

# 1 Drawer-at-a-time Mechanism R Line

Assembly Guide



# Mécanisme 1-à-la-fois Ligne R

Guide d'assemblage

- All required hardware is included.
- Please check the contents with your packing slip.
- Read instructions carefully.
- Save this document for future reference.

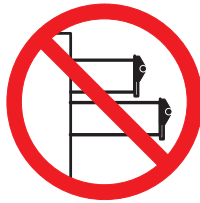

- Toute la quincaillerie requise est incluse.
- Veuillez vérifier le contenu avec votre feuille de livraison.
- Lisez attentivement les instructions.
- Conservez ces instructions pour référence future.

## Hardware

Tapping screw  
Vis taraudeuse  
3D1618L2



Glide  
Glissière  
71019300

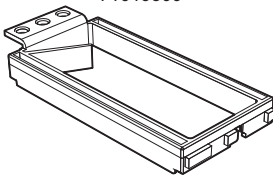

Runner  
Coulisseau  
71019600

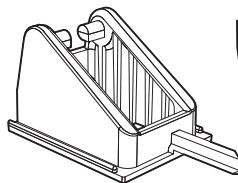

## Quincaillerie

Locking block  
Bloc d'activation  
71019000

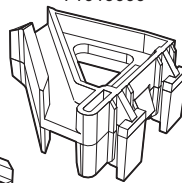

## Tools Required Outils requis



Note :

It is possible that you may receive more plastic pieces than you need depending on the number of drawers you have.  
*Il peut y avoir des pièces en plastique en trop selon le nombre de tiroirs dans votre cabinet.*

## Locking Block Assembly

## Assemblage du bloc d'activation

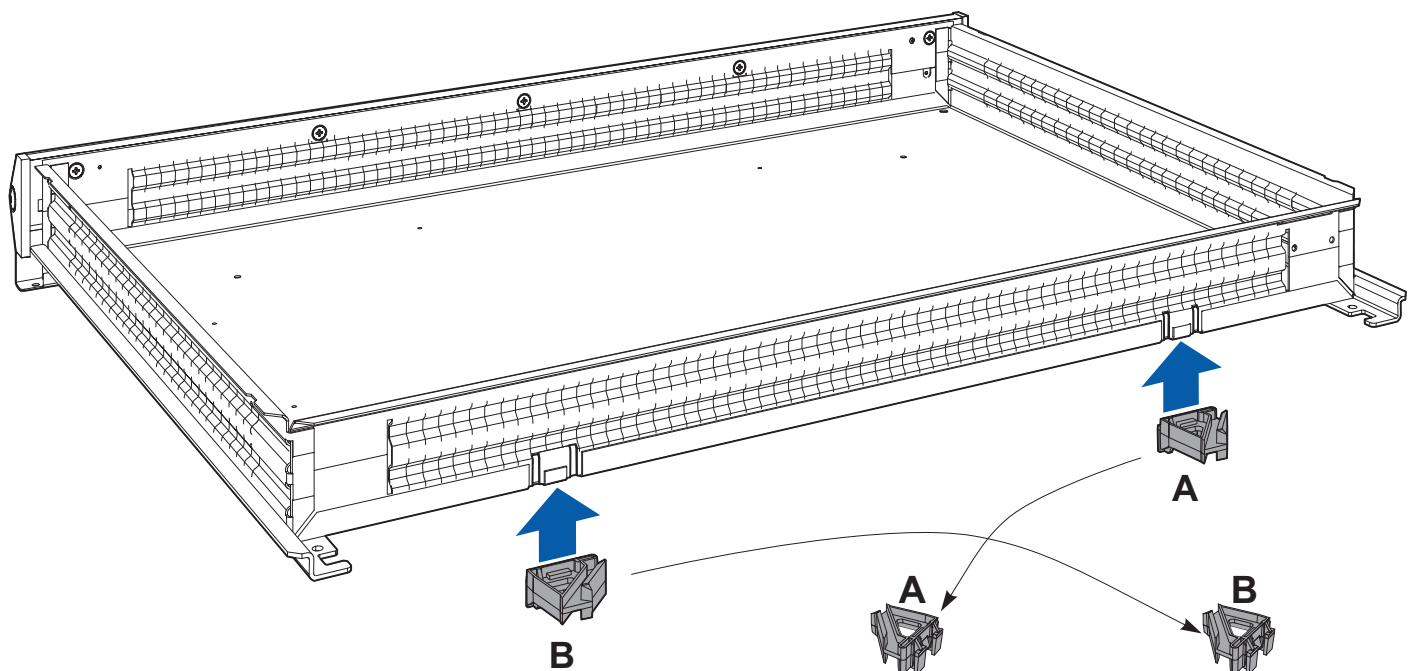

- For regular cabinets, install all locking blocks in position "B".
- For multi-drawer cabinets, install all locking blocks in position "A" and "B" as illustrated.
- Pour les cabinet régulier, installer tous les blocs d'activation dans la position "B".
- Pour les cabinets multi-tiroirs, installer tous les blocs d'activation dans la position "A" et "B", tel qu'illustré.

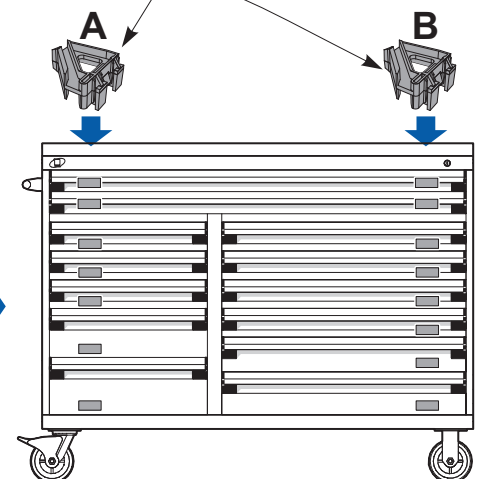

2x  5/8"

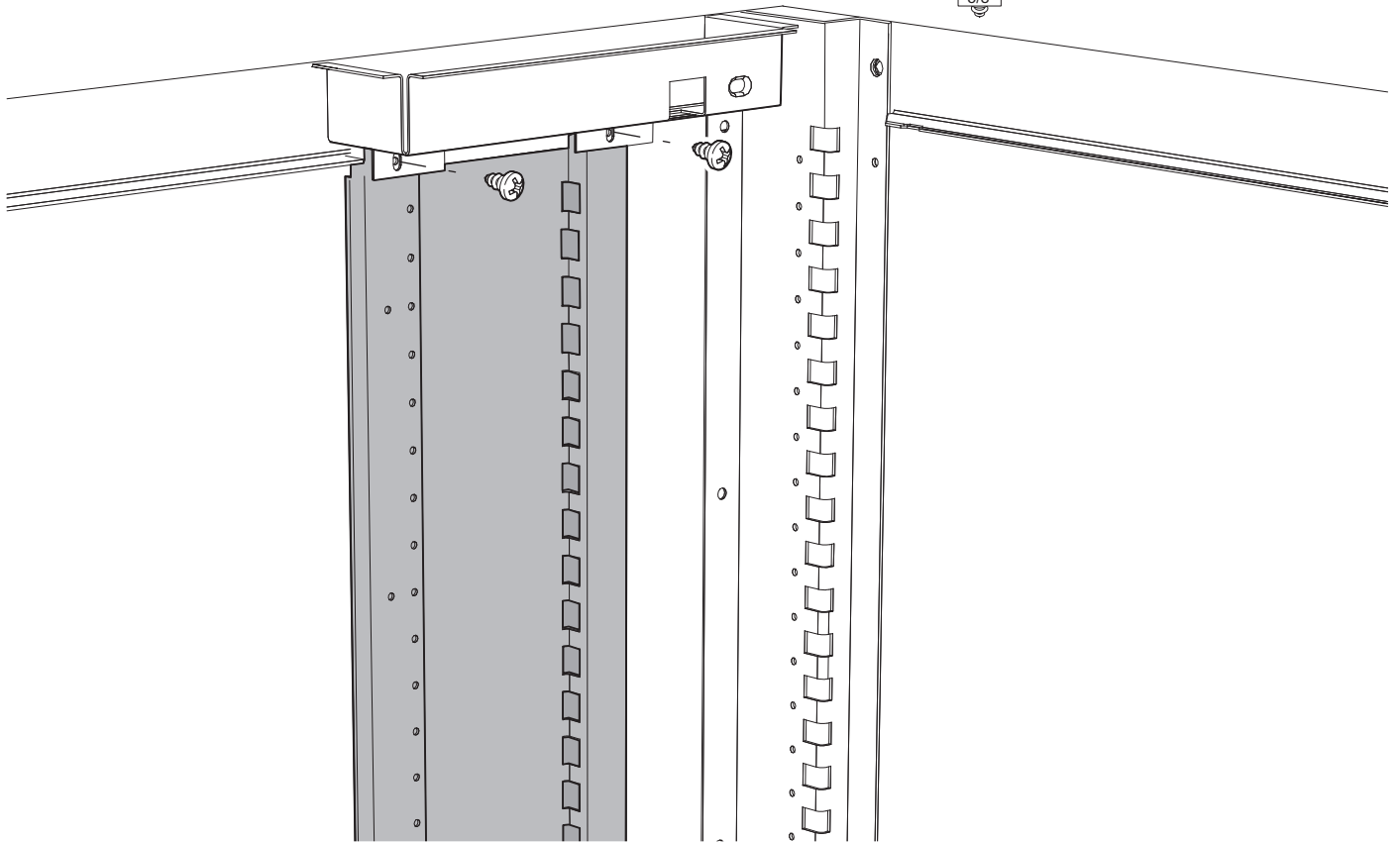

Glide and Runner

Glissière et coulisseau

 5/8" 2 per drawer / par tiroir

Activate the runner manually by sliding it to the right before installing a drawer.  
*Activer le coulisseau manuellement en le glissant vers la droite avant d'insérer un tiroir.*

